

Designing a Coreless High-Speed Axial-Flux PM Generator for Microturbines

Mohammad Sadeghirad

Department of Electrical, Computer & IT Engineering, Islamic Azad University, Qazvin Branch, Qazvin, Iran

Received 11 February 2011; revised 10 April 2011; accepted 26 April 2011

Abstract

Compactness and lightness make high-speed axial-flux machines eligible for distributed generation application with microturbine. In a high-speed generator driven by micro-turbines, the rotor speed is normally above 30,000 rpm and may even exceed 100,000 rpm. The frequency for flux variation is more than 1 kHz. Therefore, designing such a high-speed generator is quite different, in mechanical and electromagnetic respects, from designing conventional generators with low speed and low frequency. Important considerations in designing high-speed axial-flux generators (HSAFG) for microturbine are discussed in this paper. Results of the efficiency sensitivity versus air gap of the machine are also presented.

Keywords: Microturbine, High-speed generator, Axial-flux permanent magnet, Coreless stator, Design.

1 Introduction

Today, microturbines are becoming well known as energy management solutions. Microturbines are being installed in many distributed generation applications allowing end users to better manage their energy costs. They play an important role as strategic power sources in remote and disastrous areas where grid power is unavailable. The security and economy of the grid power would be enhanced with the connection of a multiple of these generators in distributed generation.

Original features such as compactness and lightness make high-speed axial flux machines eligible for application at distributed generation (with microturbine) [1].

Due to the high rotor speed and high frequency of the stator winding current, the design of a high-speed generator is more difficult than and quite different from designing a low-speed conventional generator.

In this paper, the axial flux permanent magnet synchronous alternators with coreless structure are considered to design in high speed.

2 Microturbine

Microturbine, as its name implies, is a small-size gas turbine. Generally, anything below 500 kW can be considered a microturbine. Some are used for modeling jet fighters, some are being developed for use in very small spy drones, and others are used to produce electricity. [2]

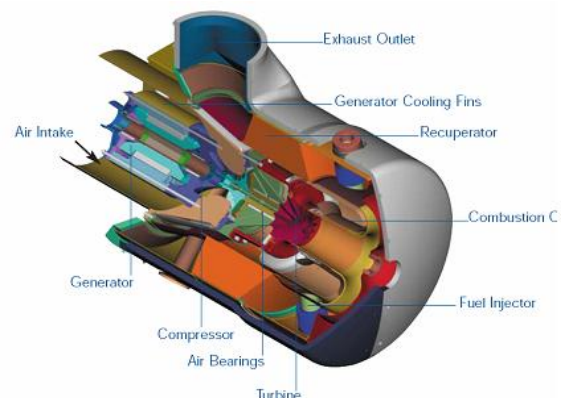

Fig.1 View of a Capstone microturbine [3]

Microturbines have been used in many different applications since the mid to late 1960's. Microturbines have powered cars and functioned as APU's (auxiliary power units) in aircraft and missiles. The telephone industry used turbines to create power for remote locations in the late 60's and early 70's. [4]

These highly efficient cogeneration systems are a reliable source of high quality heat and power at the point of energy consumption. They are all fully integrated, light weight, and virtually vibration free. Typical use could be in offices, stores, hotels, hospitals, residential homes, industrial kilns, small industries, schools, supermarkets, food processing, leisure centers and swimming pools, apartment blocks, and small-scale district heating schemes.

This Cogeneration System consists of a microturbine generator integrated with a waste heat recovery unit.

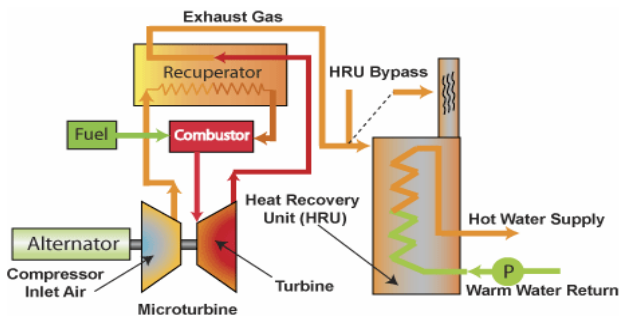

Fig. 2 Cogeneration System (CHP)

Compared to a central power station, a microturbine powered CHP system offers the following benefits:

- little or no electrical transmission and distribution (T&D) loss
- avoidance or deferral of increased T&D costs
- use of the engine heat output for high-efficiency cogeneration and trigeneration
- local variation of the heat/power ratio. This optimizes system operation and extends the annual operating hours.
- greater consumer control
- remote control and monitoring of local power quality and power features
- suitability for providing power to rural and developing regions
- allowing incremental increase in capacity at small levels of incremental cost
- avoidance of substantial approval process problems for new plants and associated T&D
- significant reduction of environmental impacts
- minimal civil and installation costs.

3 Rotor Design

Due to high speed of microturbine, the design of its

generator is quite different from designing a conventional generator. Fig. 3 is a schematic view of intended machines with three rotors and two stators.

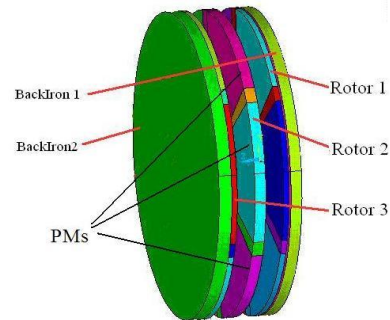

Fig. 3 Side view of high-speed axial-flux generators

Both electromagnetic and mechanical considerations play significant roles in designing the rotor of a high-speed machine compared to low-speed structures. A Permanent Magnet (PM) rotor is preferred (over induction machine, wound-field synchronous machine, BLDC machine, etc.) thanks to advantages such as simple structure, high power density, high efficiency, and no excitation power loss [5]

3.1 Choice of Permanent Magnet Material

PM machines are becoming more popular because of their advantageous features, including high efficiency, high power, etc. [6, 7]. The PM material properties have the significant meaning for a high-speed axial-flux generator. The following factors are considered in choosing PM material:

- good magnetic properties (Br, Hc, BH_{max})
- invulnerability to high operation temperature: SmCo is better than Nd-Fe-B.
- price of the PM material: SmCo is more expensive than Nd-Fe-B.

Once all the factors are taken into account, the sintered Nd-Fe-B material would be best candidate [8]. Properties of some sintered Nd-Fe-B materials are shown in Table 1.

Table 1: Properties of some sintered Nd-Fe-B materials

NEO-H Series (Max. Working Temperature: 120 °C)					
Material Code	Residual Flux Density	Coercive Force	Max. Energy Product	Temp. Coeff.	Density
	Br	KA/m	(BH) _{max}	(%/°C)	(g/cm ³)
	T	bHc	KJ/m ³	αBr	
N27H	1.00-1.08	836	199-223	-0.11	7.45-7.55
N30H	1.08-1.13	836	223-247	-0.11	7.45-7.55
N33H	1.13-1.17	836	239-263	-0.11	7.45-7.55
N35H	1.17-1.21	836	263-287	-0.11	7.45-7.55
N38H	1.21-1.25	836	287-310	-0.11	7.45-7.55
N40H	1.24-1.28	836	304-328	-0.11	7.45-7.55
N42H	1.28-1.32	836	318-342	-0.11	7.45-7.55
N45H	1.32-1.36	836	344-376	-0.11	7.45-7.55

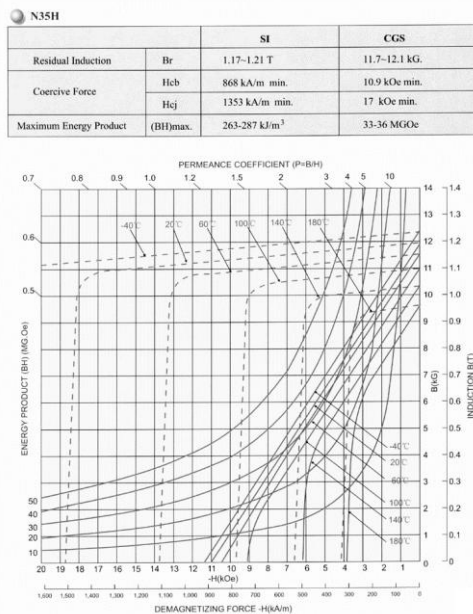

Fig. 4 Curves of N35H used in this machine

3.2 Dimension Determination

To reduce the centrifugal force, the rotor diameter should be as small as possible since the centrifugal force is proportionate to the square of rotor speed. The rotor diameter, however, should not be too small because the rotor should have enough space for housing the PM.

In its cylindrical type, the PM is not able to withstand large centrifugal forces and must be encapsulated in some high-strength material such as cylinder enclosure made of non-magnetic stainless steel and carbon fiber bandage [9]. However, this type does not need retention, which is an advantage.

3.3 Choice of Pole Number

The choice of pole number will affect the machine structure and performance. The common choices are 4, 6, 8, and 10.

Low-numbered poles have both advantages and disadvantages as described below:

- The frequency of the magnetic flux in the stator core and the frequency of the stator current are much lower, resulting in the reduction of the losses of stator core (if not coreless) and copper.
- A large PM is more difficult to manufacture than a small one.

Considering these advantages, we chose the 6-pole.

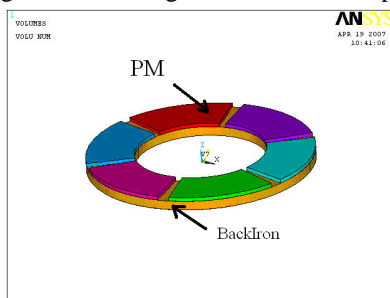

Fig. 5 View of a rotor of HSAFG

4 Stator Design

In designing the stator, the main problem is the high frequency of stator current and flux.

4.1 Stator Core Design

If the stator core materials and flux densities are the same for 3,000-and 60,000-rpm machines, the ratio of core loss per kilogram for the two machines will be about 50. This means there are two ways of reducing stator core loss:

- reducing the flux density (B) in the stator teeth and yoke, and reducing the loss coefficient (K_0) using thinner, high-quality cold-rolled silicon steel sheets (less than 0.3 mm) [10]
- using coreless stator [11]

In this machine, coreless structure is chosen.

4.2 Winding

The view of stator winding of this machine is given in Fig. 6.

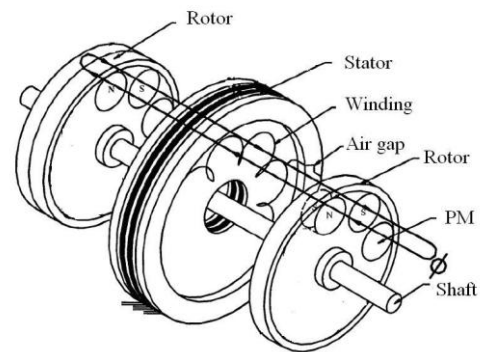

Fig. 6: Representation of a winding of stator of HSAFG

The stator winding is exposed to high-frequency current and high-frequency magnetic field. The skin effect should be considered. To reduce the skin effect, the wires of stator winding are divided into several individually insulated strands. On the other hand, Litz wire (the wire was divided into individually insulated strands with small size) is used.

5 Bearing Design

The common mechanical bearing cannot be used for a high-speed axial-flux generator (HSAFG) because the friction will shorten the running life of the bearing. With the development of new technology, two kinds of contactless bearing, air bearing and magnetic bearing, are available for the high-speed axial-flux generators.

Air bearing uses a thin film of pressurized air to support a load. This type of bearing is called a “fluid-film” bearing. The fluid can transfer forces because as the fluid is pushed through the bearing gap, it generates a pressure profile across the bearing area. Fluid-film bearing offers a number of advantages over mechanical

bearing: resistance to wear or heat generated by friction, zero static and running friction, high stiffness and self-centering, etc. it is necessary to accurately design and manufacture air bearings with extremely tight tolerances. A hybrid structure of air bearing is both radial and axial bearing.

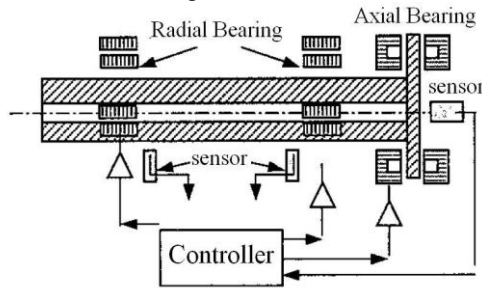

Fig. 7 Magnetic bearing

In magnetic bearings, the force for rotor suspension is generated by the electromagnetic field. Based on their structure and application, magnetic bearings can be classified into different types such as passive, active, and hybrid. The operation principle of a typical active magnetic bearing is illustrated in Fig. 7. The controller receives rotor-offset information from the sensor and then controls the rotor in the proper position by dynamically adjusting the winding current of the electric magnet.

6 Simulation

By collecting all parts of the electromagnetic model (reluctance) of the machine together, the simple model of HSAFG is obtained [12]. The performance analysis is based on the design study of a 30,000-rpm, 30-KW, and 400-V generator. The generator has been designed according to this model. For checking over the design, the FEM is used. The 2-D FE modeling of this machine can be carried out by introducing a radial cutting plane at the average radius, which is then developed into a 2-D flat model. The Neumann boundary condition is assigned to the top and bottom boundary. By modeling and solving the machine on ANSYS, the following result will be obtained (The flux density is 0.46 for FEM and 0.49 for the model).

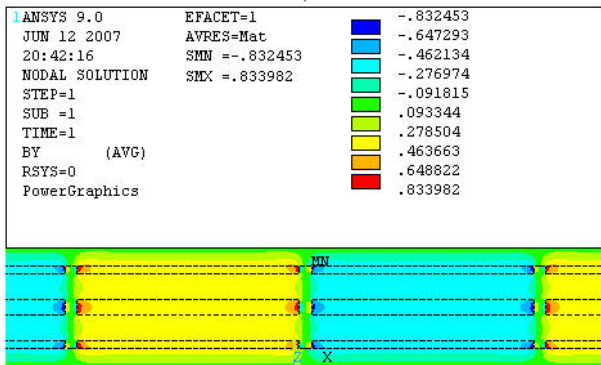

Fig. 8 Result of FEM

Air gap is very important in designing electrical machines. Figs. 6-10 show plots some output parameters due to the air gap increasing from 1mm to 8mm.

In this analysis, the speed of machine is constant (30,000 rpm) because of using the specified driver (microturbine). The output of the generator is connected to power electronic devices, and its value (400V) is not very important. The output power is defined as 30KW. Thus, with output voltage reduction more output current is needed.

the following parameters are given constant values:

D_o : outer diameter, D_i : inner diameter, L_s : length of stator, L_{pm} : length of PM, L_{bi} : length of back iron, D_{stard} : diameter of each wire of conductor, and B_r : residual flux density of PM.

Fig. 9 shows that output voltage is inversely related to air gap (at any number of poles). this relationship is because of air gap flux density (Fig. 10) and is different from conventional machines. In HSAFG, there is a strong relation. On the other hand, by each increase of 1mm in air gap, the voltage falls down intensely. At a high value of air gap, the PMs cannot produce enough flux density (Fig. 10), so the low air gap (defined by mechanical restriction) is recommend.

The second important parameter in an electrical machine is efficiency. Fig. 11 shows that in a high-speed axial flux generator, efficiency smoothly decreased, but air gap increased. However, this reduction is more significant in conventional machines because of rotation losses term in them. According to the formula of rotation losses in disk type machines, it is independent of air gap and pole numbers. Therefore, it is constant and equal to 3286W. Air friction at high speed is high.

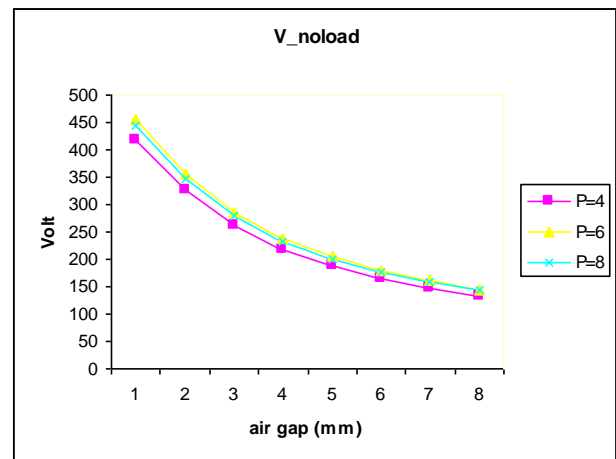

Fig. 9. Output voltage (no-load) (V) vs. air gap (m)

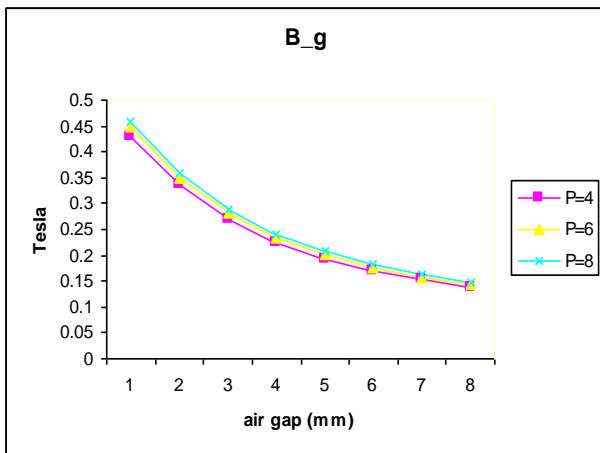

Fig. 10. Air gap flux density (B_g) (tesla) vs. air gap (m)

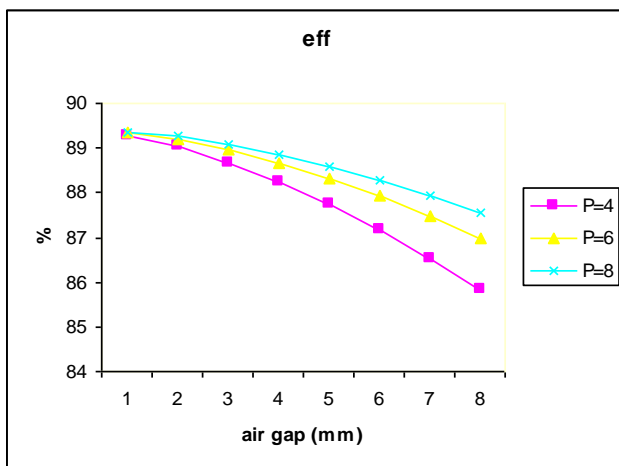

Fig. 11. Efficiency (%) vs. air gap (m)

7 Conclusion

The change of the structure of energy use and the potential market for distributed generation resources make it promising to use high-speed axial-flux generators. The main point about designing PM rotor is considering strength and stiffness for high-speed operation. For stator design, the main problem is the high frequency of the current and flux of the stator.

A design methodology for a modular high-speed axial-flux PM generator from first principles was proposed. Then, air gap analysis was performed. Variations of the main output parameter such as output voltage and efficiency were discussed. In this machine, an increase in air gap causes strength reduction in output voltage. But it has unmentioned influence on efficiency, it is because of high rotation losses in the disk type machine with high speed.

References

[1] M. Sadeghierad, A. Darabi, H. Lesani, H. Monsef; "Optimal design of the generator of microturbine using genetic algorithm and PSO", International Journal Of Electrical Power & Energy Systems (Elsevier), No 32(7), 2010 Page(s):804 – 808

- [2] Brenard F. Kolanowski, "Guid to Microturbines", the Fairmont Press, 2004
- [3] www.capstoneturbine.com
- [4] www.turbogenset.com
- [5] K.B.Sundaram, j.Vaidya, L.Zhao, D.Acharya, C.H.Ham, J.Kapat, and L.Chow" Analysis and Test of a High-Speed Axial flux permanent magnet Synchronous motor", Electric Machines and Drives, IEEE International Conference on, May 15, 2005 Page(s):119 - 124
- [6] A.Vahedi and M.Ramezani; "Analysis of converter-permanent magnet synchronous machine set by improved average-value modeling"; Iranian Journal of Electrical & Electronic Engineering, Vol.1, No.2, April 2005, page(s) 81-87
- [7] Nasiri Gheidari Z., Lesani Hamid, Toutounchian F.; "New Hunting Control Method for Permanent Magnet Hysteresis Motors"; Iranian Journal of Electrical & Electronic Engineering, Vol.2, No.3-4, July 2006 page(s) 106-120
- [8] Gieras J.F., Wang R.J., Kamper M.J.; "Axial Flux Permanent Magnet Brushless machine", Kluwer Academic Publisher; 2005
- [9] Fengxiang Wang; Ming Zong; Wenpeng Zheng; Enlu Guan; "Design features of high speed PM machines" Electrical Machines and Systems, 2003.ICEMS 2003. Sixth International Conference on (IEEE CNF), Volume 1, 9-11 Nov. 2003 Page(s):66 - 70 vol.1
- [10] Wang Fengxiang; Zheng Wenpeng; Zong Ming; Wang Baoguo; "Design considerations of high-speed PM generators for microturbines", Power System Technology, 2002. Proceedings. PowerCon 2002. International Conference on (IEEE CNF), Volume 1, 13-17 Oct. 2002 Page(s):158 - 162 vol.1
- [11] Sadeghierad M., Lesani H., Monsef H., and Darabi A.; "High-Speed Axial-Flux PM Generator with Coreless Stator", Canadian Journal Of Electrical and Computer Engineering, Volume 34, 2009 Page(s):63-67
- [12] Sadeghierad, M.; Lesani, H; Monsef, H.; and Darabi, A.; "Leakage Flux Consideration in modeling of High Speed Axial Flux PM Generator", ICIT08, IEEE International; 21-24 April 2008