

Multi-Step-Ahead Prediction of Stock Price Using a New Architecture of Neural Networks

Mohammad Talebi Motlagh^{*}, Hamid Khaloozadeh

Department of Systems and Control, Industrial Control Center of Excellence, K.N.Toosi University of Technology, Tehran, Iran

Abstract

Modelling and forecasting Stock market is a challenging task for economists and engineers since it has a dynamic structure and nonlinear characteristic. This nonlinearity affects the efficiency of the price characteristics. Using an Artificial Neural Network (ANN) is a proper way to model this nonlinearity and it has been used successfully in one-step-ahead and multi-step-ahead prediction of different stocks prices. Several factors, such as input variables, preparing data sets, network architectures and training procedures, have huge impact on the accuracy of the neural network prediction. The purpose of this paper is to predict multi-step-ahead prices of the stock market and derive the method, based on Recurrent Neural Networks (RNN), Real-Time Recurrent Learning (RTRL) networks and Nonlinear Autoregressive model process with exogenous input (NARX). This model is trained and tested by Tehran Securities Exchange data.

Keywords: stock price; neural network; predict; multi-step-ahead prediction.

1. Introduction

Due to the absence of accurate information influencing the stock price, linear regression models such as ARIMA models are unable to provide a useful prediction of price. After 1980, there has been a turnover in the field of time series prediction, when it became clear that this type of prediction is a suitable application for an ANN. Over the last few decades, ANNs have become one of the successful techniques that are being used for modelling stock market behaviour.

In stock trading, it is very desirable that the models provide an accurate multi-step-ahead prediction. A simple neural network is unable to provide a reliable long-term prediction [1]. Lately, RNNs have attracted much attention for multistep-ahead predicting. Due to their dynamic nature, RNNs have been applied successfully to a wide variety of problems, such as financial time series [2], peak power load forecasting [3] and stream-flow forecasting [4].

An architectural approach of RNN with embedded memory, NARX network, shows promising qualities for dynamic system applications. Studies show that

^{*} Corresponding author. Email: m_talebi@outlook.com

NARX networks are often much better at discovering long term dependencies than RNNs [5].

Most of the presented neural networks are static, which can only simulate the short-term memory structures within process; consequently some characteristics could not be modelled well. The RTRL networks, which represent dynamic internal feedback loops to store information for later use and to enhance the efficiency of learning, provide a better way for modelling [6].

2. Neural Networks

The basic idea for forecasting is usually the case that additional information from previous observed values and model outputs will be useful to forecast the future values. When a neural network is used to forecast, results tend to be closer to the true values, as the model can be iteratively adjusted through model performance with a reduction of errors.

2.1. RNN Networks

To predict the future behaviour of a process, it is necessary to model its dynamics. RNNs are capable of representing arbitrary nonlinear dynamical systems.

The RNN shown in Fig. 1 is used in [1] for long-term prediction of stock market. This network has an architecture, which is based on the error vector as an auxiliary input vector. In this network, each element of the output vector represents the daily price which is to be predicted. In fact, the predicted values of price for several days ahead are estimated using the available price daily data.

In the training procedure of this network, the price values of the next T days are predicted using price values of the last N days and actual error of estimation for the next $T - 1$ days. In the test procedure the error vector is considered zero since the actual price of the next $T - 1$ days are not available.

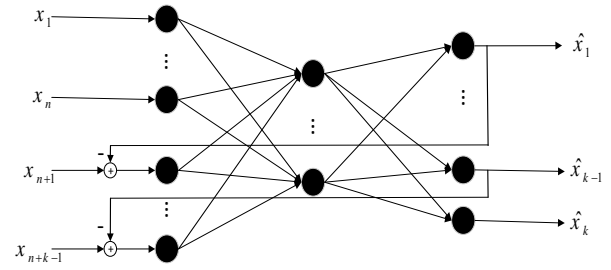

Fig. 1. RNN for long-term prediction

2.2. RTRL Networks

Another RNN as shown in Fig. 2 which has used RTRL algorithm, is applied in [6] for two-step-ahead prediction of stream flow. This network has a representation of dynamic internal feedback loops to store information for later use. This would enhance the efficiency of learning. As indicated in the architecture of this network, the outputs of the hidden layer are fed back to the input of the network. In aforementioned RNN network, all layers perform a simultaneous mapping process $(x(t) \rightarrow y(t) \rightarrow z(t))$. However, in this network, each layer perform a one-step-ahead mapping process $(x(t) \rightarrow y(t+1) \rightarrow z(t+2))$.

2.3. NARX Networks

NARX is a useful mathematical model of discrete-time nonlinear systems.

Nonlinear systems can be approximated by a NARX network, which is a powerful dynamic model for time series prediction.

$$Y(t) = f\left(X(t - D_X), \dots, X(t - 1), X(t), Y(t - D_Y), \dots, Y(t - 1)\right) \quad (1)$$

Where, $X(t)$ and $Y(t)$ represent the input and output of the network at time t , D_X and D_Y are the input and output orders, and the function f is a nonlinear function. The architecture of a NARX network based on a multilayer perceptron neural network, consists of D_X antecedent values of

exogenous input vectors $X(t)$; D_y previous actual values $Y(t)$, which are tapped-delay inputs or fed back from the model's output; and a single n-step-ahead output $Y(t+n)$.

The NARX model for multi-step-ahead prediction, can be implemented in many ways, but the simpler, seems to be by using a feedforward neural network with the embedded memory, as shown in Fig. 3 and a delayed connection from the output of the second layer to input. This network is used in [5] for prediction of chaotic time series.

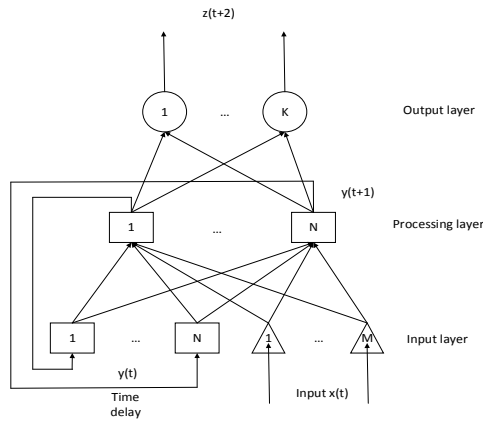

Fig. 2. RTRL for two-step-ahead prediction

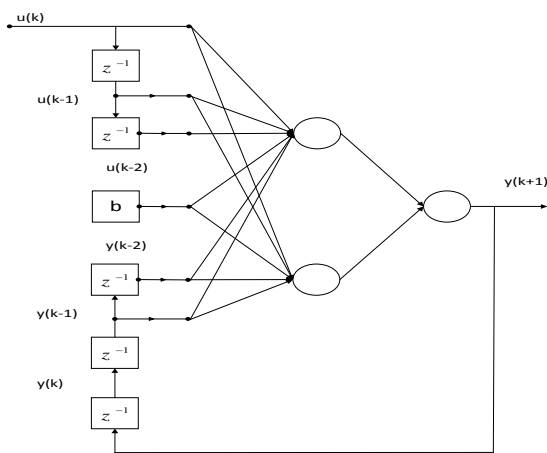

Fig. 3. Architecture of the R-NARX network during training and testing phases in the recurrent mode.

This fact has been observed previously, in the sense that gradient-descent learning is more effective in NARX networks than in RNN network architectures [7].

3. The proposed architecture

In this section a new architecture of neural network, as depicted in Fig. 4, is presented for two-step-ahead prediction of stock prices. An earlier version of the proposed architecture was presented in [8]. As the architecture shows, outputs of the hidden layer and output errors are considered as additional inputs. When the output errors are applied as input as in [1], the network tends to learn the error dynamics during the training procedure. In the validation and test procedure, since the output errors are not available, they are considered zero. When the outputs of the hidden layer are fed back, the network would maintain a sort of state that could perform such tasks as sequence prediction which are beyond the power of a standard multilayer perceptron. It also enhances the efficiency of learning.

3.1. Data Normalization

This process helps to normalize the minimum and maximum values of each data series to a boundary. In this case because of the nature of the sigmoid function, which is used as the transfer function of the network, the input data need to be in $[-1,1]$. Log-return is used for normalizing here. The rationale is that the movement of the price value is more important than absolute value of the movement, whether it is going up or down and how much the movement is in percentage. The definition of log-return is:

$$X_{normalized} = \log \left(\frac{X(t)}{X(t-1)} \right) \quad (2)$$

3.2. Network topology

There are infinite ways to construct a neural network. The architecture of a neural network defines its geometrical structure.

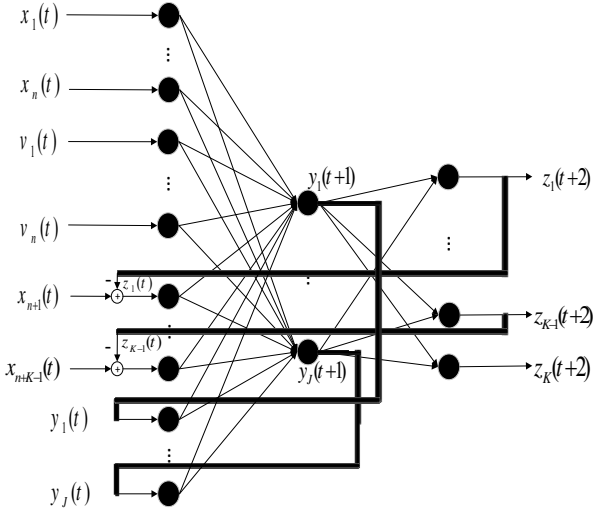

Fig. 4. Proposed network for multi-step-ahead prediction

The following factors have to be considered in designing a proper neural network:

- The number of inputs: in this network the following matrix is used as input

$$X = [X_n \quad V_n \quad E \quad Y]^T \quad (3)$$

- where, x_n and v_n are the normalized closing price and normalized trading volume, E is the actual error of estimation as used in [1] and Y is the output of the hidden layer. The price and the volume of the two past days are used as input.
- The number of hidden layers: Theoretically, a neural network that has one hidden layer and sufficient number of hidden neurons is capable of generalizing any continuous function [9]. In this network one hidden layer is used.
- The number of neurons in each layer: In order to find the optimal number of neurons, the network is performed for different numbers of neurons.
- The number of outputs: Since the goal is two-step-ahead prediction, the network has two outputs.

3.3. Training Procedure

The process of training a neural network is to let the network learn patterns in the training data. The goal of this process is to find the best set of weights and biases. For this network, gradient-descent

backpropagation has been applied, to find the desired set of weights and bias. 70% of the data are used for training, 15% for validation and 15% for testing. Hyperbolic tangent function is used as the transfer function of the hidden layer and purlin is used for the output layer. The same method as used in [1] and mentioned in 2.1. is used here for training and testing.

Fig. 4 shows the proposed network for two-step-ahead prediction.

Specifying how to adjust weights and biases, is the main issue in the training procedure of this network. Since the output of the hidden layer and the output layer are fed back to the input, the adjustment formulas of the weights and the biases should be recalculated for this network.

Let A denote the set of indices i for which $x_i(t)$ is the stock price, B denote the set of indices i for which $Y_i(t)$ is the volume of the stock trade, C denote the set of indices i for which $e_i(t)$ is the error of the network output and D denote the set of indices i for which $Y_i(t)$ is the output of the hidden layer of the network. Thus the input is defined by

$$\mu_i(t) = \begin{cases} x_i(t) & i \in A \\ v_i(t) & i \in B \\ e_i(t) & i \in C \\ y_i(t) & i \in D \end{cases} \quad (4)$$

The net activity and the output of the neuron j and neuron k are computed by

$$\begin{aligned} net_j(t+1) &= \sum_{i \in A \cup B \cup C \cup D} w_{ji}(t) \mu_i(t) + b_1(t) \\ y_j(t+1) &= f_1(net_j(t+1)) \\ net_k(t+2) &= \sum_{i \in A \cup B \cup C \cup D} v_{kj}(t+1) \times \\ & \quad y_j(t+1) + b_2(t+1) \\ z_k(t+2) &= f_2(net_k(t+2)) \end{aligned} \quad (5)$$

Where, i, j, k respectively represent the index of the each input, each neuron of the hidden layer and

each output. The error of the prediction for k th day at time $t + 2$ is

$$e_k(t + 2) = d_k(t + 2) - z_k(t + 2) \quad (6)$$

Where, $d_k(t + 2)$ is the desired output at time $t + 2$. Then the network error at time $t + 2$ and the total network error are

$$E(t + 2) = \frac{1}{2} \sum_k e_k^2(t + 2) \quad (7)$$

$$E_{total} = \sum_{t=1}^T E(t + 2)$$

Since the gradient descent is used for back propagation, the weights and biases should be adjusted as follows

$$\begin{aligned} \Delta v_{kj}(t + 1) &= -\eta_v \frac{\partial E(t + 2)}{\partial v_{kj}(t + 1)} \\ \Delta w_{ji}(t) &= -\eta_w \frac{\partial E(t + 2)}{\partial w_{ji}(t)} \\ \Delta b_2(t + 1) &= -\eta_{b_1} \frac{\partial E(t + 2)}{\partial b_2(t + 1)} \\ \Delta b_1(t) &= -\eta_{b_2} \frac{\partial E(t + 2)}{\partial b_1(t)} \end{aligned} \quad (8)$$

Where, η_v , η_w , η_{b_1} and η_{b_2} are the learning rates of the weights and biases of the layers. The partial derivative terms can be obtained by the chain rule for differentiation. For Δv we have

$$\begin{aligned} \frac{\partial E(t + 2)}{\partial v_{kj}(t + 1)} &= \frac{1}{2} \frac{\partial}{\partial v_{kj}(t + 1)} \sum_k e_k^2(t + 2) \\ &= e_k(t + 2) \frac{\partial e_k(t + 2)}{\partial v_{kj}(t + 1)} \\ &= -e_k(t + 2) \frac{\partial z_k(t + 2)}{\partial v_{kj}(t + 1)} \\ &= -e_k(t + 2) \times \\ &\quad f_2'(net_k(t + 2)) \frac{\partial net_k(t + 2)}{\partial v_{kj}(t + 1)} \\ &= -e_k(t + 2) \times \\ &\quad f_2'(net_k(t + 2)) y_j(t + 1) \\ \rightarrow \Delta v_{kj}(t + 1) &= \eta_v e_k(t + 2) \times \\ &\quad f_2'(net_k(t + 2)) y_j(t + 1) \end{aligned} \quad (9)$$

For Δw we have

$$\begin{aligned} \frac{\partial E(t + 2)}{\partial w_{mn}(t)} &= \frac{1}{2} \frac{\partial}{\partial w_{mn}(t)} \sum_k e_k^2(t + 2) \\ &= \sum_k e_k(t + 2) \frac{\partial e_k(t + 2)}{\partial w_{mn}(t)} \\ &= -\sum_k e_k(t + 2) \frac{\partial z_k(t + 2)}{\partial w_{mn}(t)} \\ &= -\sum_k \left\{ e_k(t + 2) v_{kj}(t + 1) \times \right. \\ &\quad \left. f_2'(net_k(t + 2)) \right\} \frac{\partial y_j(t + 1)}{\partial w_{mn}(t)} \end{aligned} \quad (10)$$

It could be assumed that the synaptic weights do not rely on the initial state of the network at time $t = 0$, so we have

$$\begin{aligned} \frac{\partial y_j(0)}{\partial w_{mn}(0)} &= 0 \\ \frac{\partial y_j(t+1)}{\partial w_{mn}(t)} &= f_1'(net_j(t+1)) \frac{\partial net_j(t+1)}{\partial w_{mn}(t)} \\ \frac{\partial net_j(t+1)}{\partial w_{mn}(t)} &= \sum_{i \in A \cup B \cup C \cup D} \frac{\partial w_{ji}(t)}{\partial w_{mn}(t)} \mu_i(t) \quad (11) \\ &\quad + w_{ji}(t) \frac{\partial \mu_i(t)}{\partial w_{mn}(t)} \\ \frac{\partial w_{ji}(t)}{\partial w_{mn}(t)} &= \begin{cases} 0 & j = m \ \& \ i = n \\ 1 & \text{other} \end{cases} = \delta_{jm} \delta_{in} \end{aligned}$$

The value of δ_{jm} is 1, if and only if $j = m$; otherwise 0.

$$\begin{aligned} \frac{\partial \mu_i(t)}{\partial w_{mn}(t)} &= \begin{cases} 0 & i \in A \\ 0 & i \in B \\ \frac{\partial e_i(t)}{\partial w_{mn}(t)} & i \in C \\ \frac{\partial y_i(t)}{\partial w_{mn}(t)} & i \in D \end{cases} \quad (12) \\ \frac{\partial e_i(t)}{\partial w_{mn}(t)} &= -v_{kj}(t-1) \frac{\partial y_j(t-1)}{\partial w_{mn}(t)} f_2'(net_k(t)) \end{aligned}$$

Since i is a member of C set, then k is equal to $1, 2, \dots, (K+1)$, where K is the total number of the outputs. Let

$$\begin{aligned} a_{mn}^j(t) &\square \frac{\partial y_i(t)}{\partial w_{mn}(t)} \\ \frac{\partial y_i(t+1)}{\partial w_{mn}(t)} &\approx \frac{\partial y_i(t+1)}{\partial w_{mn}(t+1)} = a_{mn}^j(t+1) \quad (13) \\ \frac{\partial y_j(t-1)}{\partial w_{mn}(t)} &\approx \frac{\partial y_j(t-1)}{\partial w_{mn}(t-1)} = a_{mn}^j(t-1) \end{aligned}$$

Thus $a_{mn}^j(t)$ can be calculated by the following recursive equation

$$\begin{aligned} a_{mn}^j(t+1) &= f_1'(net_j(t+1)) \left[\delta_{jm} \mu_n(t) - \sum_{i \in C} w_{ji}(t) v_{kj}(t-1) \times \right. \\ &\quad \left. a_{mn}^m(t-1) f_2'(net_k(t)) + \sum_{i \in D} w_{ji}(t) a_{mn}^i(t) \right] \quad (14) \end{aligned}$$

With the initial condition $a_{mn}^j(0) = 0$.

Since i is a member of D set in the term $\sum_{i \in D} w_{ji}(t) a_{mn}^i(t)$, then j is equal to $1, 2, \dots, J$, where J is the total number of the neurons in the hidden layer.

Then the weight adjustment for $w_{ji}(t)$ can be computed by

$$\begin{aligned} \Delta w_{mn}(t) &= \eta_w \sum_k (e_k(t+2) v_{kj}(t+1) \times \\ &\quad f_2'(net_k(t+2))) a_{mn}^j(t+1) \quad (15) \end{aligned}$$

Similarly bias adjustment relations are obtained by

$$\begin{aligned} \Delta b_2(t+1) &= \eta_{b_1} e_k(t+2) f_2'(net_k(t+2)) \\ \Delta b_1(t) &= \eta_{b_2} \sum_k (e_k(t+2) v_{kj}(t+1) \times \\ &\quad f_2'(net_k(t+2))) a_{mn}^j(t+1) \quad (16) \end{aligned}$$

However, for the biases, $a_{mn}^j(t)$ will be obtained by

$$\begin{aligned} a_{mn}^j(t+1) &= f_1'(net_j(t+1)) \times \\ &\quad \left[- \sum_{i \in C} w_{ji}(t) v_{kj}(t-1) \times \right. \\ &\quad \left. a_{mn}^m(t-1) f_2'(net_k(t)) + \sum_{i \in D} w_{ji}(t) a_{mn}^i(t) \right] \quad (17) \end{aligned}$$

4. Application and Results

In order to verify the performance of proposed network, an experiment has been carried out on real stock data. The network is applied to predict two-step-ahead closing value of Saderat Bank exchange (BSDR) form June 10th of 2009 to October 5th of 2015. For comparison, RNN network, NARX network and RTRL network are also performed. Mean Square Error (MSE), Root Mean Square Error (RMSE), Normalized Mean Square Error (NMSE) and Mean Absolut Error (MAE) are used to compare the prediction precision of these models. The definition of these error indices are given by

$$\begin{aligned}
 MSE &= \frac{1}{N} \sum_{i=1}^N (z_i - d_i)^2 \\
 MAE &= \frac{1}{N} \sum_{i=1}^N |z_i - d_i| \\
 RMSE &= \sqrt{\frac{1}{N} \sum_{i=1}^N (z_i - d_i)^2} \\
 NMSE &= \frac{|z - d|}{|d|}
 \end{aligned} \tag{18}$$

Where, N represents the total number of data points, z_i is the prediction result of i th day, d_i is the desired output of i th day and e is the estimation error. The smaller the value of these indices, the more precise the prediction model will be.

Daily price of Saderat Bank exchange form June 10th of 2009 to October 5th of 2015 is used for simulation. Fig. 5 shows the closing price and the trading volume chart of BSDR for the given date range.

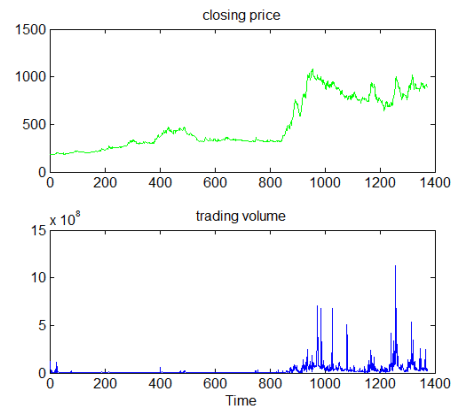

Fig. 5. BSDR daily closing price and trading volume

4.1. RNN Network

The same network used in [1] which is presented in II.A is used here with 2 inputs, 1 hidden layer, 3 neurons in the hidden layer, 2 output neurons, hyperbolic tangent function as the transfer function of the hidden layer and the output layer.

4.2. NARX Network

A NARX network as described in 2.3. is used here with 2 days price as input, 1 hidden layer with 3 neurons, 2 outputs, hyperbolic tangent function as the transfer function of the hidden layer and the output layer. Both input and output orders (D_x, D_y) are set to 2.

4.3. Proposed Architecture

The proposed network is configured as described in III. The training procedure is performed in 800 epochs in all four of the networks.

4.4. Simulation Results

The network is performed for different values of learning rate and as mentioned in 3.2. for different neuron numbers, in order to find the best parameters. Table 1 shows the networks MSE and MAE errors for different neuron numbers and different learning rate values. This table indicates that the optimal values of these two parameters are $j = 3$ and $\eta = 0.1$.

Table 1

MSE and MAE errors of the network for different neuron numbers (j) and different learning rate (η)

j	$\eta = 0.1$		$\eta = 0.2$		$\eta = 0.3$		$\eta = 0.6$	
	MAE	MSE	MAE	MSE	MAE	MSE	MAE	MSE
2	3.46×10^{-2}	2.346×10^{-3}	3.46×10^{-2}	2.349×10^{-3}	3.45×10^{-2}	2.351×10^{-3}	3.51×10^{-2}	2.35×10^{-3}
3	3.45×10^{-2}	2.345×10^{-3}	3.46×10^{-2}	2.346×10^{-3}	3.46×10^{-2}	2.349×10^{-3}	∞	∞
4	3.46×10^{-2}	2.346×10^{-3}	3.46×10^{-2}	2.346×10^{-3}	3.45×10^{-2}	2.348×10^{-3}	∞	∞
5	3.46×10^{-2}	2.346×10^{-3}	3.45×10^{-2}	2.348×10^{-3}	3.46×10^{-2}	2.347×10^{-3}	∞	∞
7	3.47×10^{-2}	2.347×10^{-3}	3.45×10^{-2}	2.350×10^{-3}	∞	∞	∞	∞
11	3.52×10^{-2}	2.35×10^{-3}	∞	∞	∞	∞	∞	∞
15	3.52×10^{-2}	2.35×10^{-3}	∞	∞	∞	∞	∞	∞

The performance of the four networks is evaluated by MSE, MAE, RMSE and NMSE. Table 2 shows the performance of the four explained networks. According to the results, all four of the criterions indicate that the proposed network performs better than the other networks.

Fig. 6 represents one-step-ahead and two-step-ahead predictions of the proposed network for BSDR. Real price is shown by green line, one-step-ahead prediction is shown by red dashed line and two-step-ahead prediction is shown by blue dashed line.

Table 2

Prediction error of different networks

	Proposed network	RNN	NARX	RTRL
MSE	2.3454×10^{-3}	2.3914×10^{-3}	2.6373×10^{-3}	2.3834×10^{-3}
MAE	3.45×10^{-2}	3.45×10^{-2}	3.73×10^{-2}	3.51×10^{-2}
RMSE	4.84×10^{-2}	4.88×10^{-2}	5.14×10^{-2}	4.88×10^{-2}
NMSE	0.9937	0.9947	1.0118	1.0103

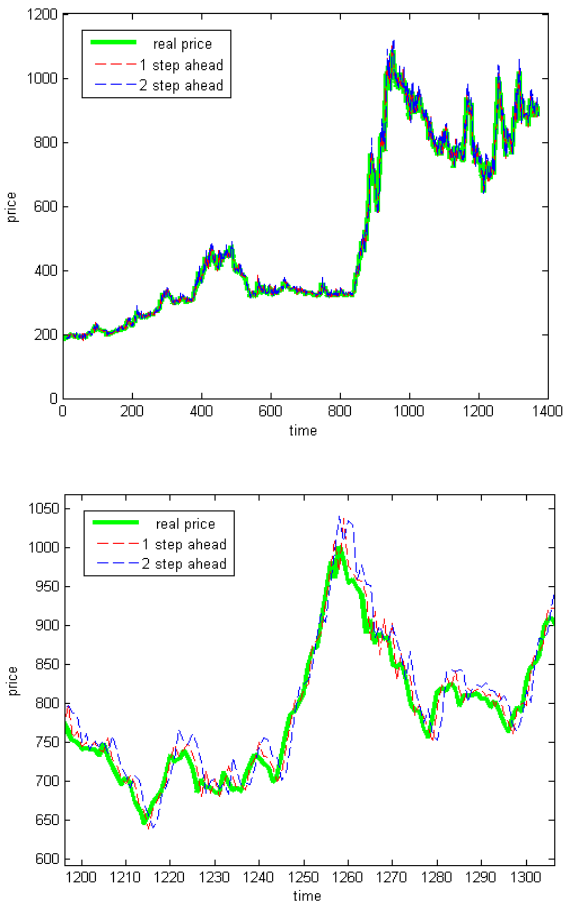

Fig. 6. One-step-ahead and two-step-ahead prediction of the proposed network

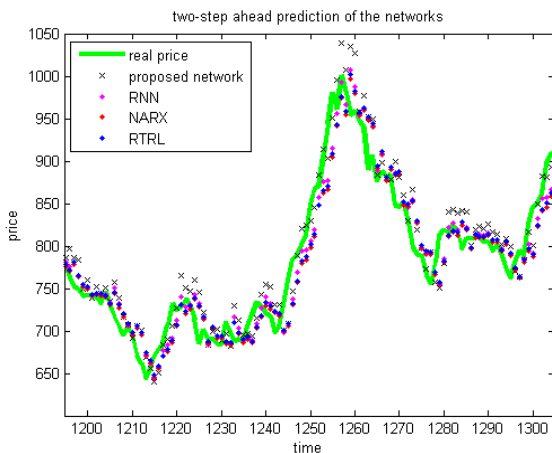

Fig. 7. Two-step-ahead prediction of the four networks

Fig. 7 represents two-step-ahead prediction of the networks.

As the results indicate, the proposed network has a better performance and could be effective in modeling such dynamic system.

5. Conclusions

Decision making under uncertainty problems, such as portfolio optimization, peak power load and flood warning systems, which have a dynamic structure, require a proper multi-step-ahead prediction. In this paper a method for two-step-ahead prediction has been proposed, which could be extended for more future time steps. For comparison, two-step-ahead forecasting by using RNN network, NARX network and RTRL network were also performed. The results showed that the proposed architecture outperforms the aforementioned networks and yields a prediction with less error.

References

- [1] H. Khaloozadeh, A. K. Sedigh, 2001. "Long term prediction of Tehran price index (TEPIX) using neural networks". In IFSA World Congress and 20th NAFIPS International Conference. Joint 9th (Vol. 1, pp. 563-567). IEEE.
- [2] E. W. Saad, D. V. Prokhov, D. C. Wunch, 1998. "Comparative study of stock trend prediction using time delay, recurrent and probabilistic neural networks". IEEE Transactions on Neural Networks 9(6):1456-1470.
- [3] H. C. Huang, R. C. Hwang, J. G. Hsieh, 2002. "A new artificial intelligent peak power load forecaster based on non-fixed neural networks". International journal of electrical power & energy systems, 24(3), 245-250.
- [4] P. Coulibaly, F. Anctil, B. Bobee, 2001. "Multivariate reservoir inflow forecasting using temporal neural networks". Journal of Hydrological Engineering 6(5):367-376.
- [5] E. Diaconescu, 2008. "The use of NARX Neural Networks to predict Chaotic Time Series". WSEAS Transactions on Computer Research 3(3):182-191.
- [6] L. C. Chang, F. J. Chang, Y. M. Chiang, 2004. "A two-step-ahead recurrent neural network for stream-flow forecasting". Hydrological Processes, 18(1), 81-92.

- [7] T. Lin, B. G. Horne, P. Tiño, C. L. Giles, 1996. "Learning long-term dependencies in NARX recurrent neural networks". *Neural Networks, IEEE Transactions on*, 7(6), 1329-1338.
- [8] M. T. Motlagh, H. Khaloozadeh, 2016. "A new architecture for modelling and prediction of dynamic systems using neural networks: application in Tehran stock exchange". In *4th International Conference on Control, Instrumentation and Automation (ICCIA)*, 2016.
- [9] A. S. Chen, M. T. Leung, H. Daouk, 2003. "Application of neural networks to and emerging financial market: forecasting and trading the Taiwan stock Index". *Computers and Operations Research*, vol. 30.